

IoT bosques 2023

Internet de las Cosas en la gestión
de los recursos naturales y la
biodiversidad.

- 📍 Aula del Amogable (Navaleno, Soria)
- 📅 28-29 septiembre 2023
- 🚩 Más info: www.pfcyl.es



Organiza:



Colaboran:



IoT y Smart Cities: desarrollo
de macetas sensorizadas
para ambientes urbanos



föra
forest technologies



föra forest technologies



Maceta inteligente en espacios urbanos

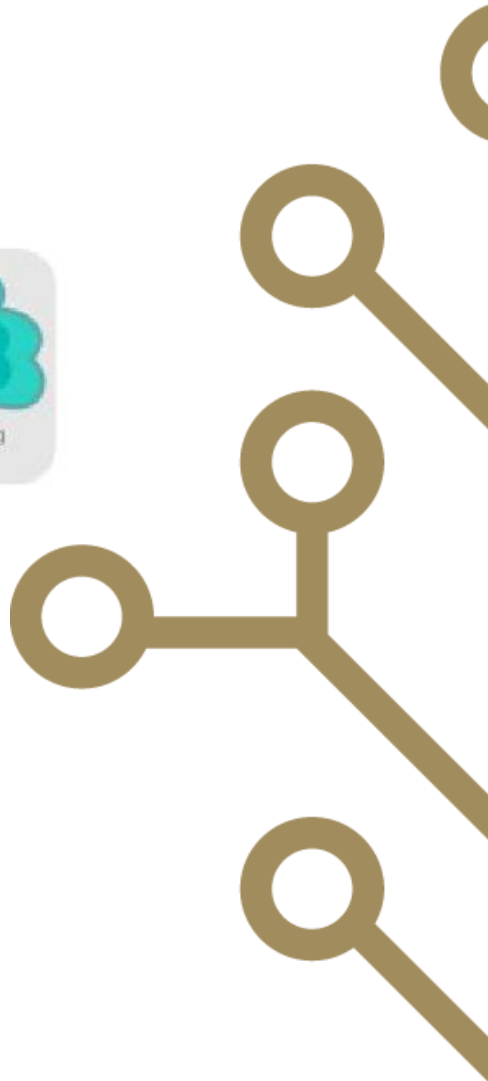
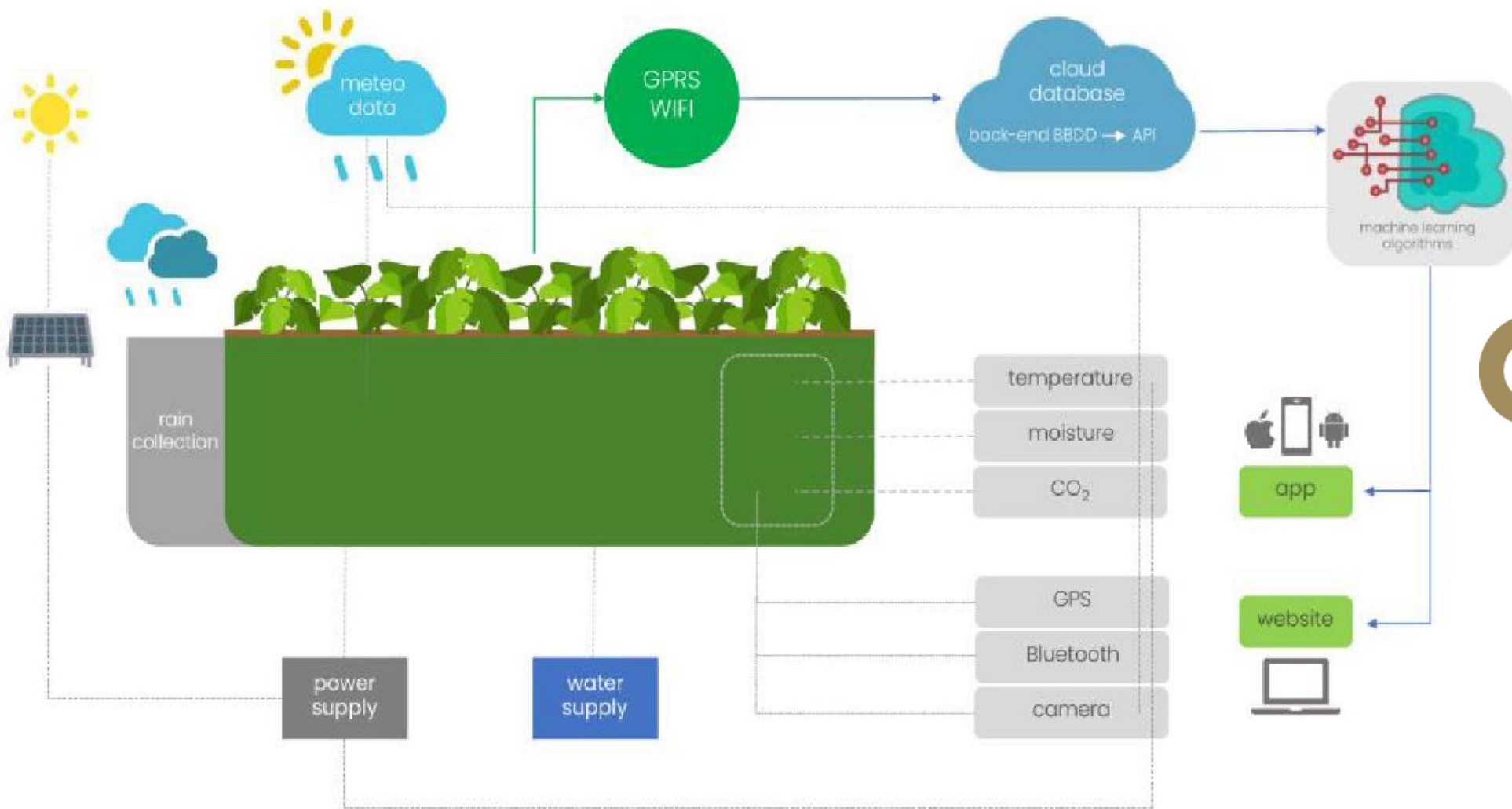

Participantes en el desarrollo



Roles:

- ❖ Implementación software
- ❖ Servicios cloud



Roles:

- ❖ Diseño de la maceta
- ❖ Algoritmos para los sistemas de irrigación



Roles:

- ❖ Desarrollo de la electrónica y comunicación
- ❖ Fabricación de sensores



Roles:

- ❖ Usuario final
- ❖ Marketing y Ventas



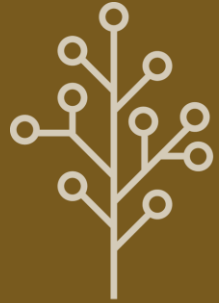

föra
forest technologies

Objetivos

Desarrollo de un prototipo:

- ❖ Diseño y fabricación de un **prototipo funcional**
- ❖ Prueba de **funcionamiento** por varias entidades

Riego automatizado

- ❖ Establecimiento de un **plan de riego** personalizado
- ❖ Seguimiento de las dosis de riego

Monitorización

- ❖ **Humedad** de la tierra y ambiente
- ❖ **Temperatura** de la tierra y ambiente
- ❖ **Irradiancia**
- ❖ Carga de la **batería**
- ❖ Nivel del **depósito** de agua
- ❖ **Ubicación**

Escala del prototipo:

Análisis de varios prototipos con diferentes tamaños
De más pequeño a más grande

Comercialización y Marketing:

- ❖ **Análisis** del mercado y comercialización de productos



Maceta inteligente en espacios urbanos

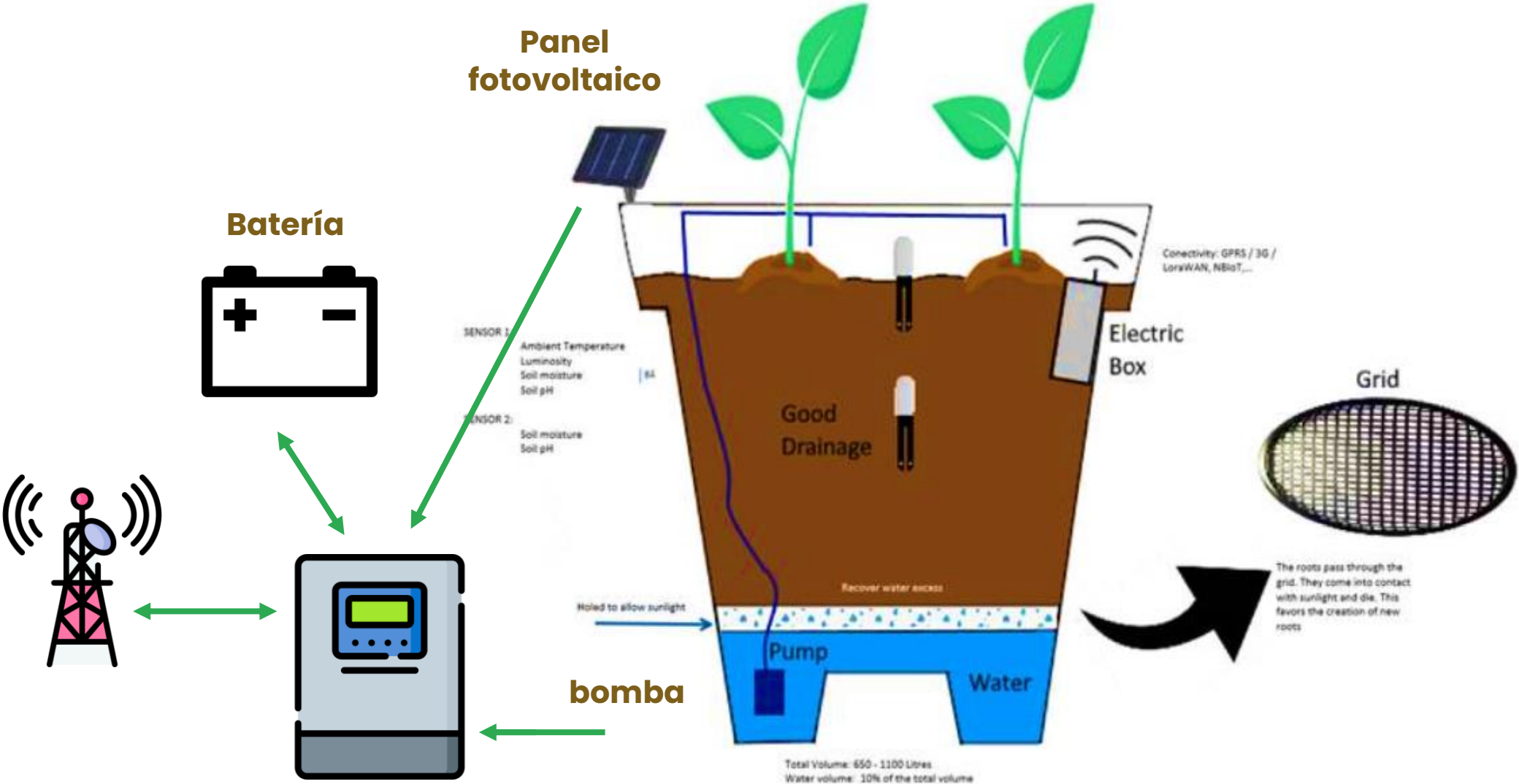

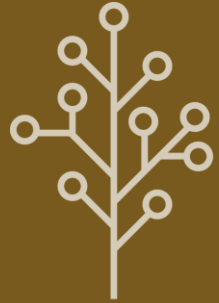

föra
forest technologies

Desarrollo

Primeros pasos

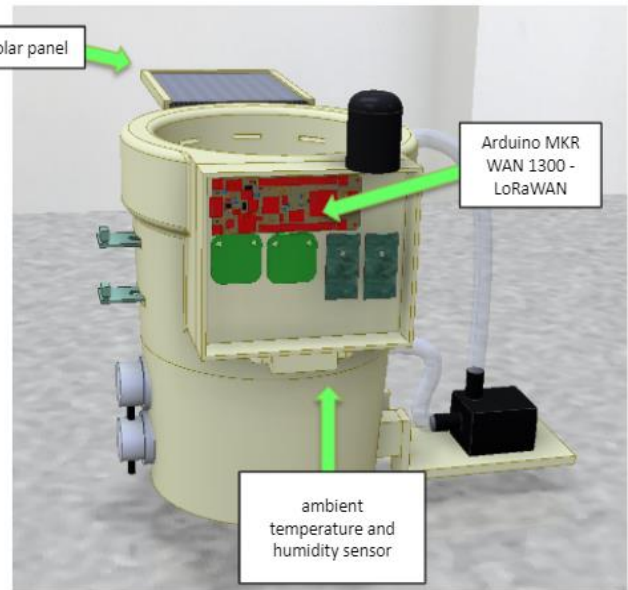
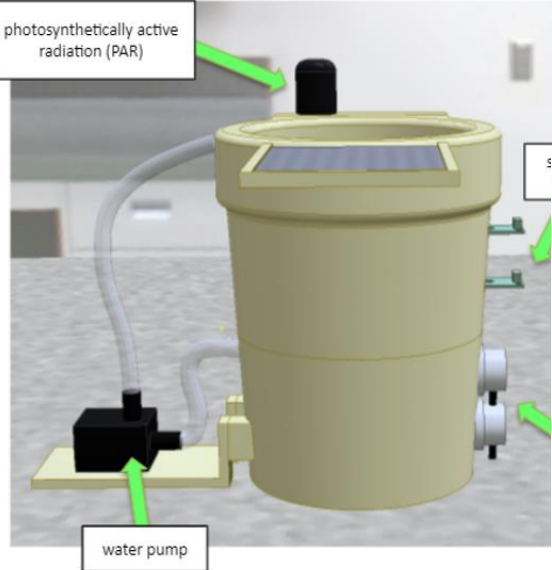
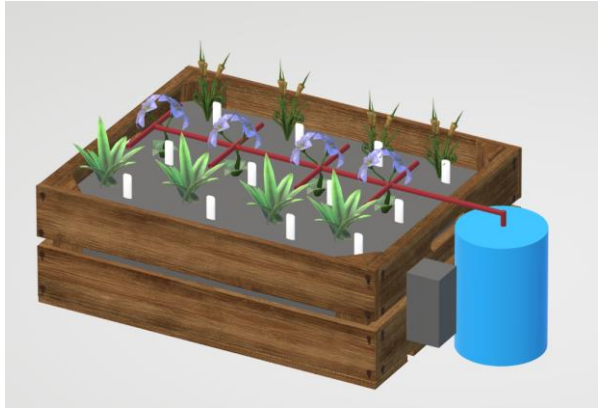
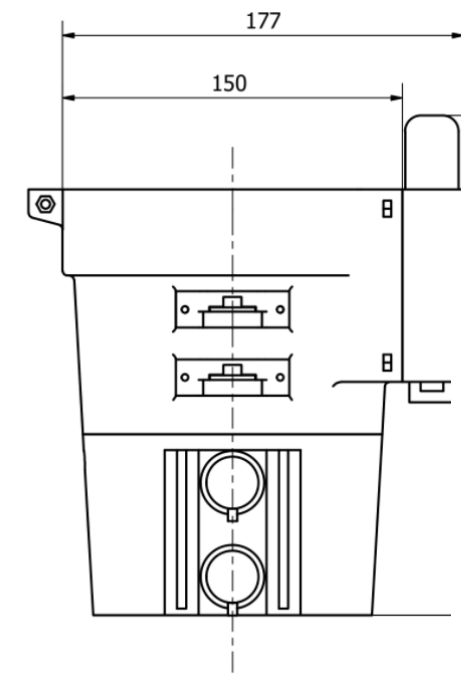
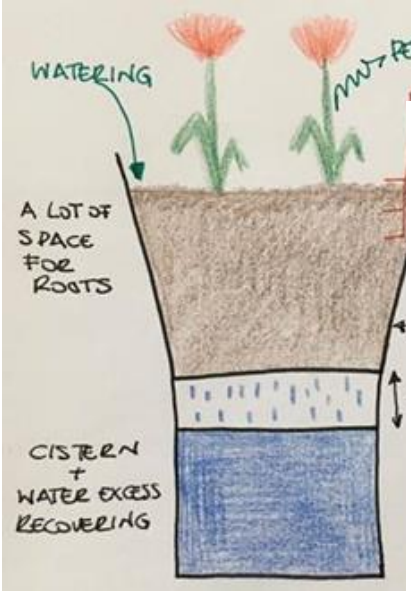

Primer diseño 3D

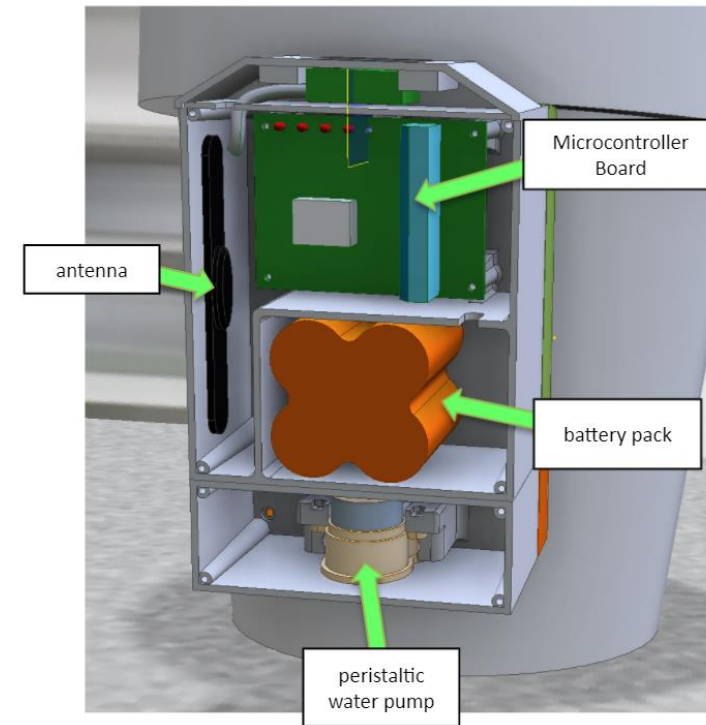
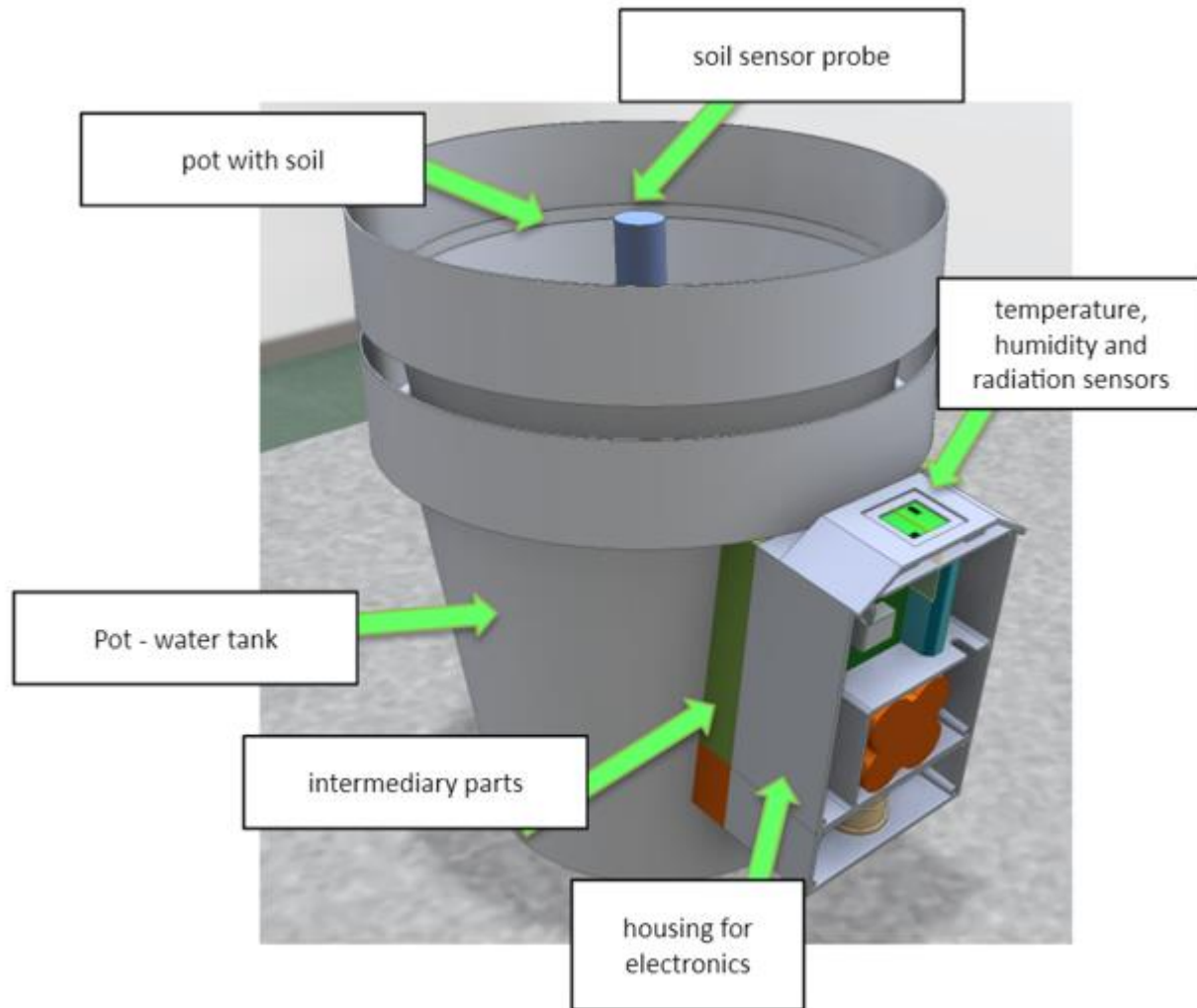

Primer prototipo

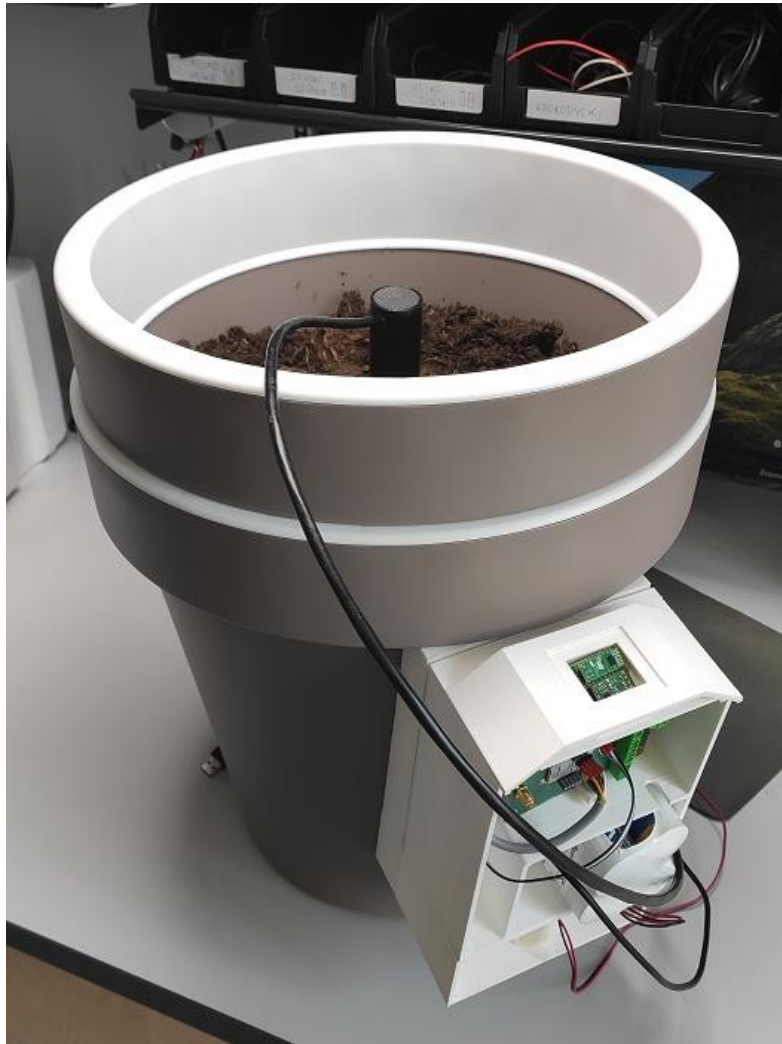

Segundo prototipo

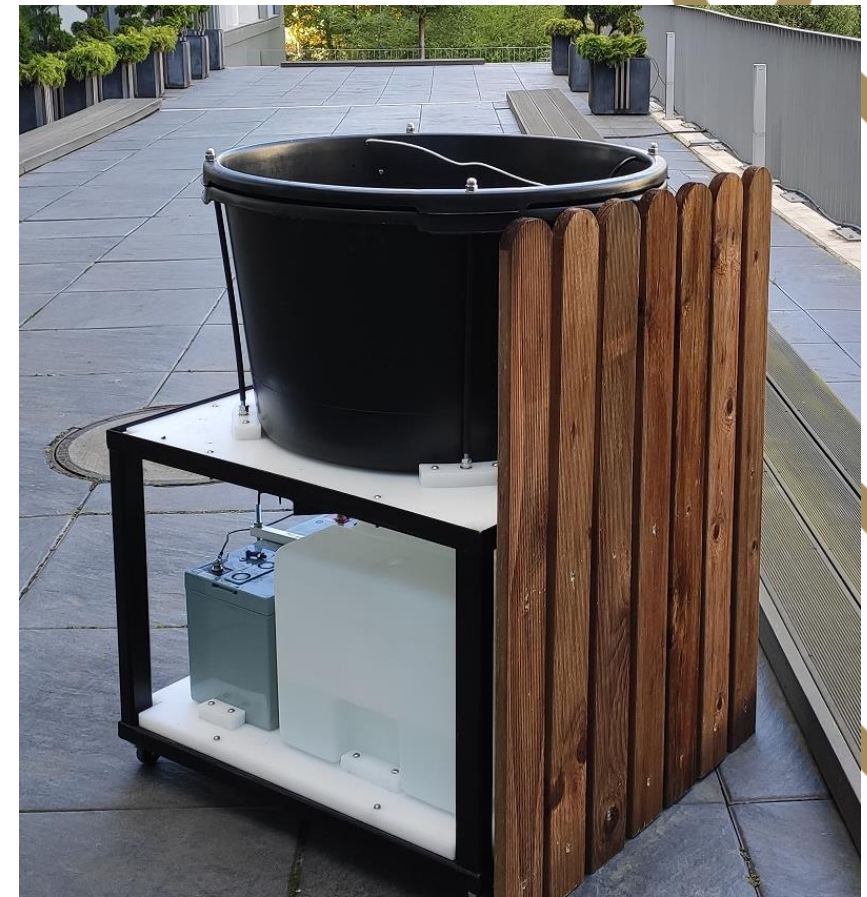

Resultado



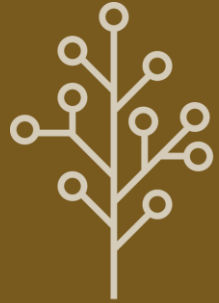

föra
forest technologies

Monitorización

Aplicación web

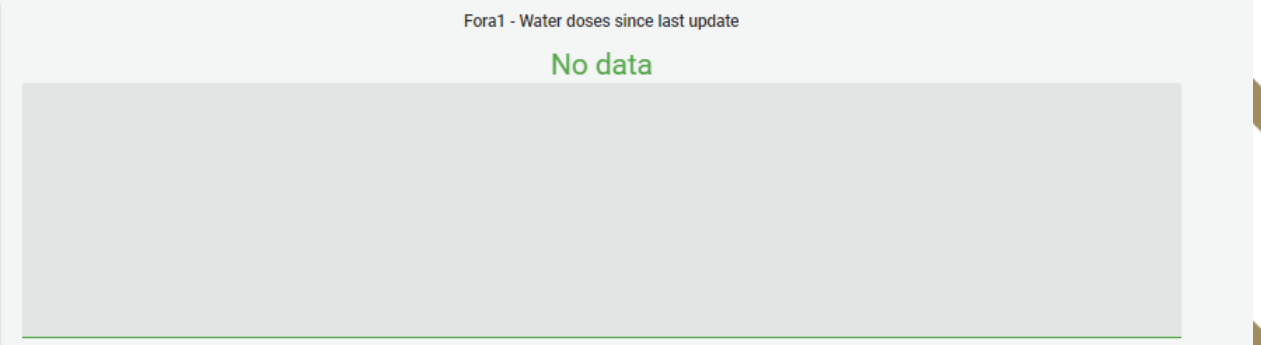
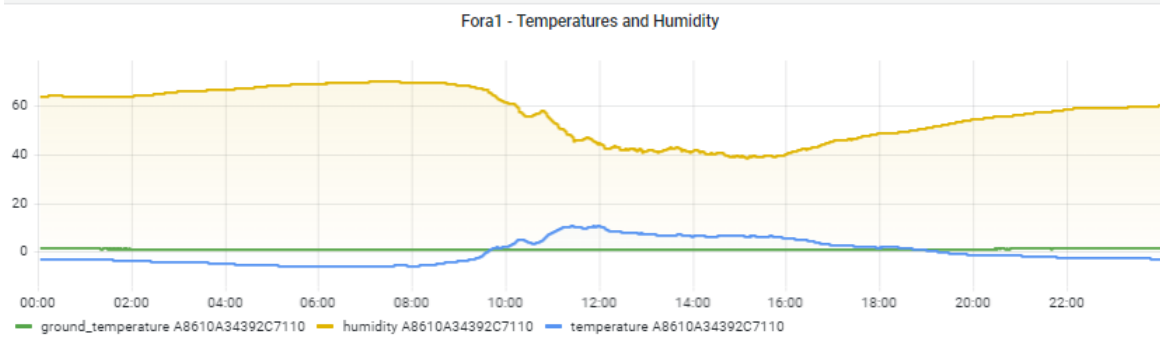
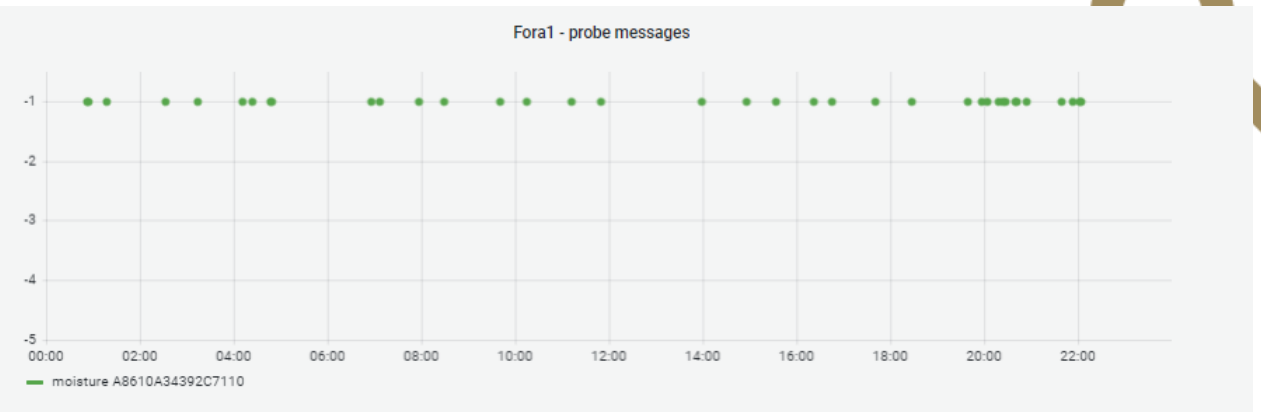
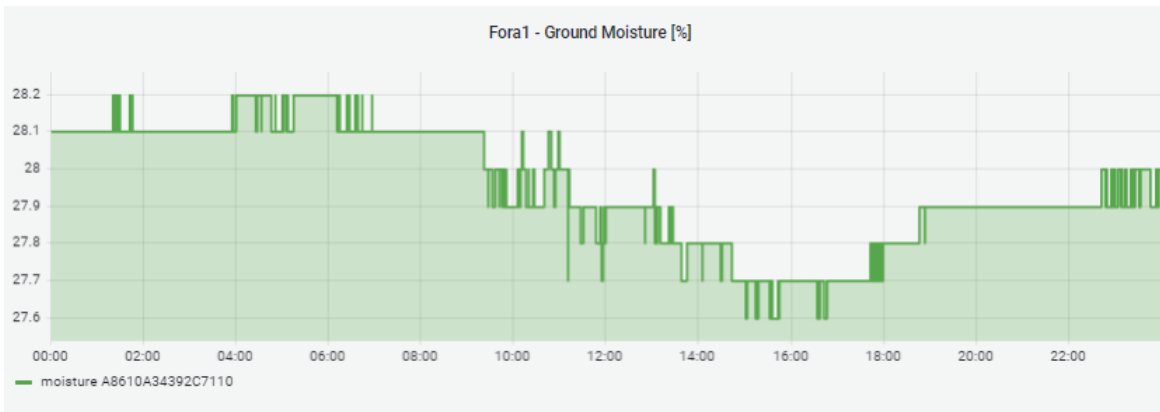

Aplicación web

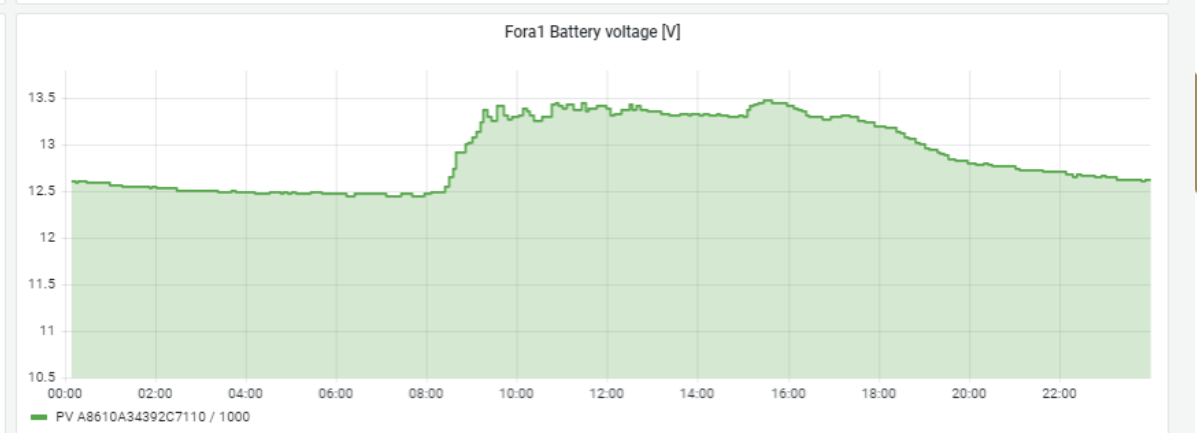
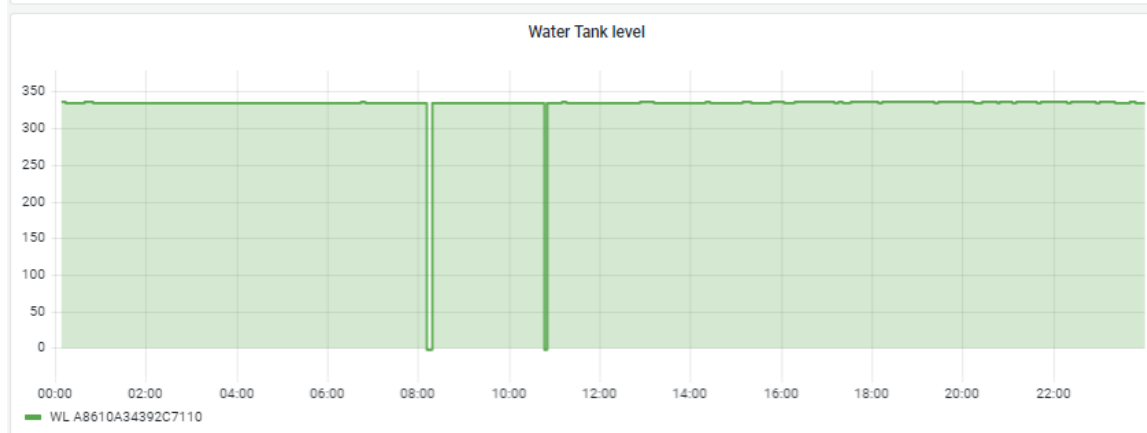
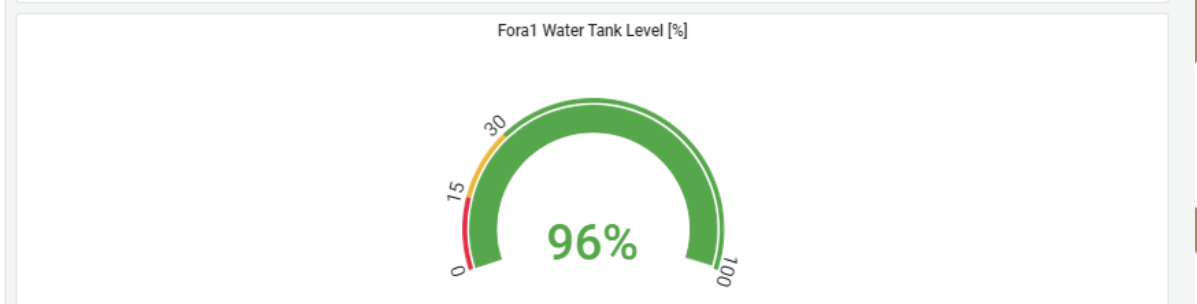
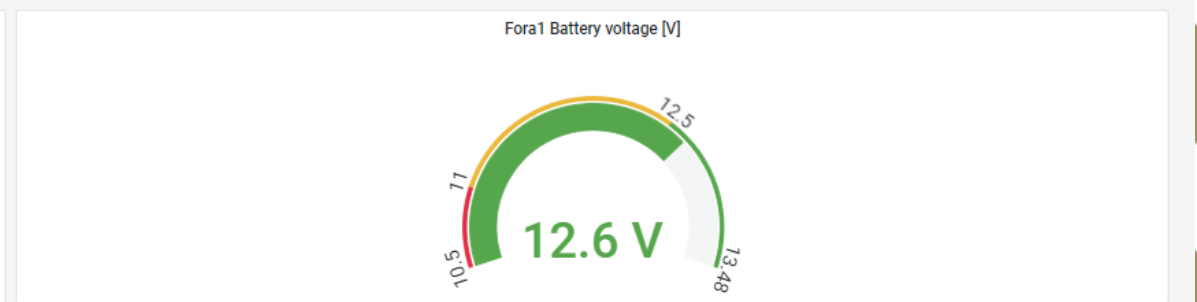
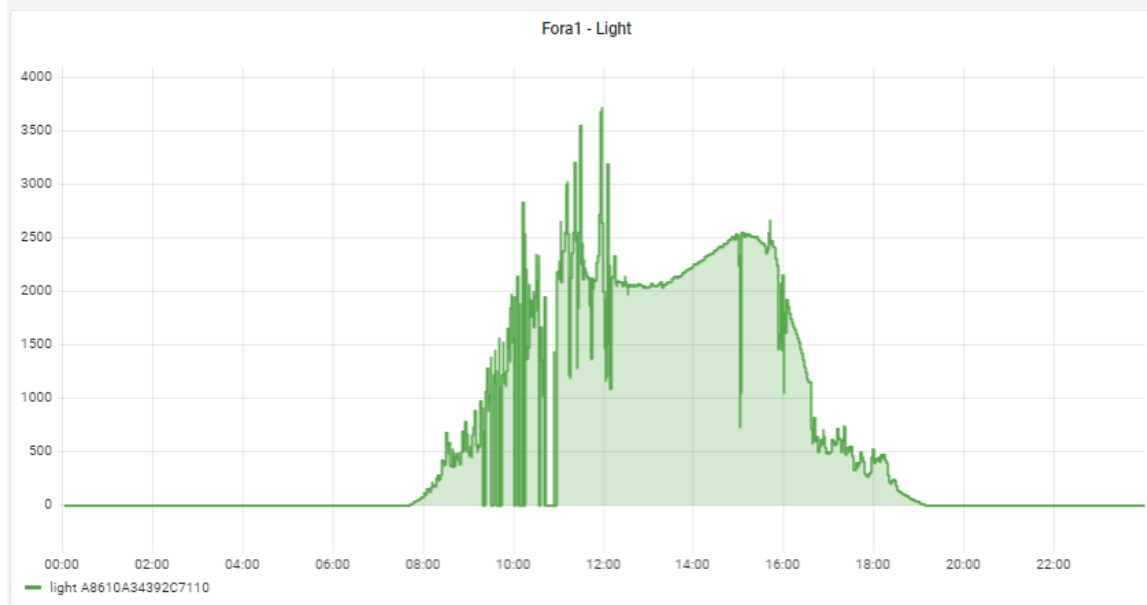

Aplicación web



Aplicación móvil

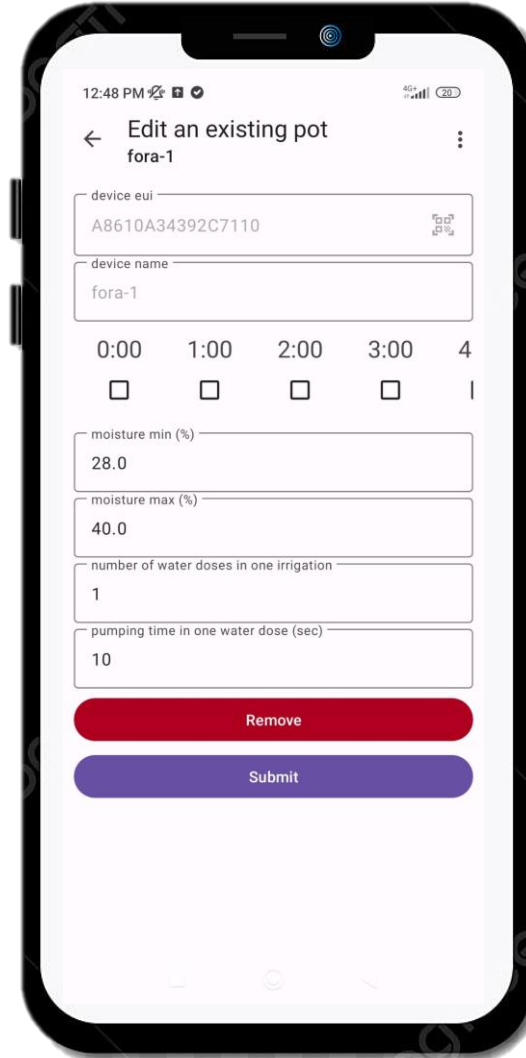
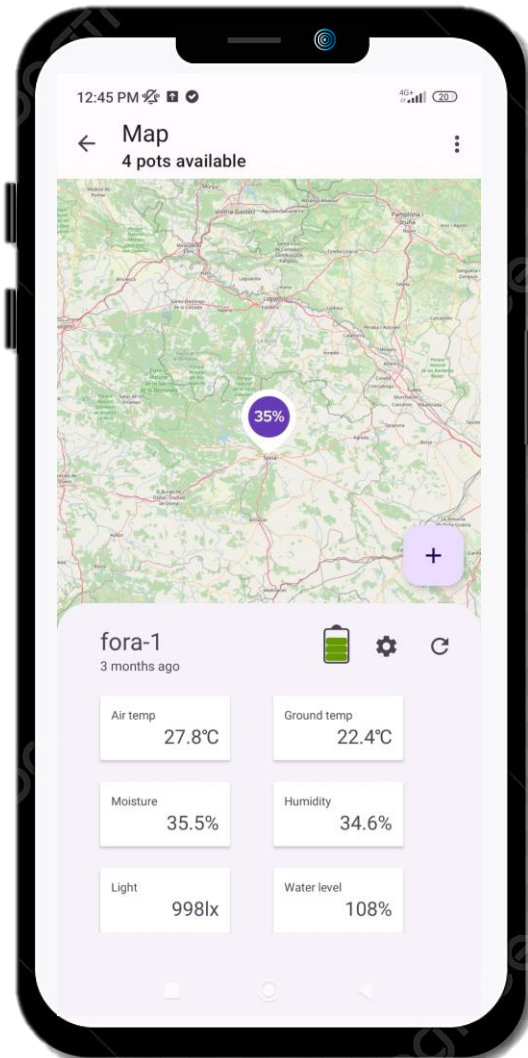

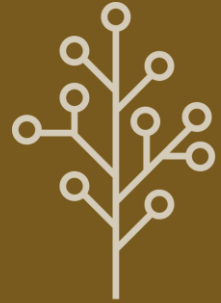

föra
forest technologies

Próximos pasos:
Escalado

Próximos pasos: Escalado

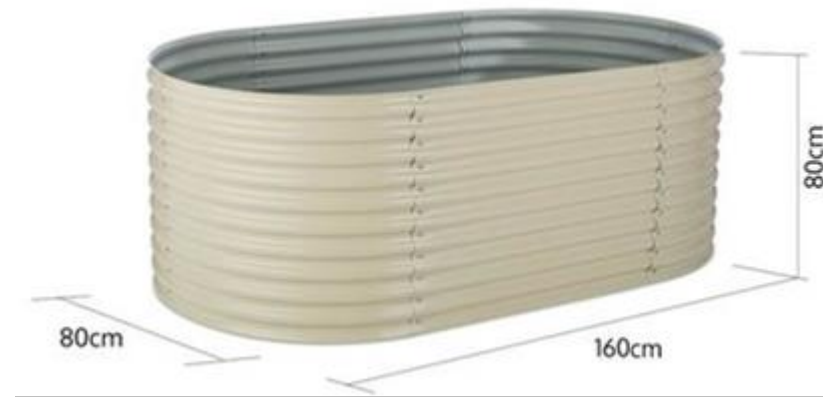

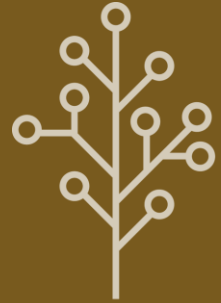

föra
forest technologies

desarrollo de
macetas
sensorizadas para
ambientes urbanos

¡gracias!